

OPERATION INSTRUCTION

Working station for split water heater: SP118 and SP228

Contents

1. Instruction
2. Attention
3. Liability waiver
4. Single pipeline working station system SP118
 - 4.1. Main technical data
 - 4.2. Components of pipeline
 - 4.3. Installation description
5. Double pipeline working station system SP228
 - 5.1. Main technical data
 - 5.2. Components of pipeline
 - 5.3. Installation description
6. Operation instruction
 - 6.1. Commissioning
 - 6.1.1. Setting the clock/ week
 - 6.1.2. Choosing the solar system
 - 6.1.3. Operation switch
 - 6.2. Temperature query function
 - 6.3. Device setup
 - 6.3.1. Setting the Clock/ week
 - 6.3.2. Systems selection
 - 6.3.3. System
 - 6.3.4. System
 - 6.3.5. System
 - 6.3.6. System
 - 6.3.7. System
 - 6.3.8. System
 - 6.3.9. System
 - 6.3.10. System
 - 6.3.11. On/Off of temperature difference setting function for temperature difference circulation pump
 - 6.3.12. Protection for water tank at high temperature
 - 6.3.13. Protection for collector at high temperature
 - 6.3.14. Collector emergency cut-off
 - 6.3.15. Protection for collector at low temperature
 - 6.3.16. Collector pipeline frost protection
 - 6.3.17. Temperature-setting for hot water circulation pump
 - 6.3.18. Time-setting for hot water circulation pump
 - 6.3.19. Time controlled auxiliary heating at preset three time sections
 - 6.3.20. Holiday function
 - 6.3.21. Permit / Prohibit auxiliary heating
 - 6.3.22. Switch on/off auxiliary heating manually
 - 6.3.23. Auxiliary function
 - 6.3.24. Auto function
 - 6.3.25. Protection function

- 6.4 Trouble shooting
- 6.4.1 Trouble protection
- 6.4.2 Error checking

Note: The operation instruction maybe is not completely conformable with the purchased working station system since improving and systematization of products from time to time. We are apologized for it and hope you understand.

1.Introduction

Solar intelligent working station system (SP series) are suitable for separated pressurized solar system, by linking the solar collector and water tank to transform solar energy into heat. It is kept monitoring system temperature, pressure, flow, etc. which is part of the heart in separated pressurized solar system.

2.Attention

- 1 Connecting the power, be sure no leakage of pipes.
- 2 Opening the housing of product only by professional person!
- 3 Please don't make the controller wet or drenched!
- 4 Please don't use this working station at the weather of thunder storm!
- 5 Customers who use auxiliary heating please install leakage protection by yourself!
- 6 The working station must not be installed in rooms where easily inflammable gas mixtures are present or may occur.
- 7 The permissible environmental conditions must not be exceeded at the site of installation.
- 8 Before connecting the device, make sure that the energy supply matches the specifications of working station on the type plate.
- 9 All operations on an open regulator are only to be conducted cleared from the power supply.
- 10 The working station system must be installed vertically.

3.Liability waiver

The manufacturer cannot monitor the compliance with these instructions or the circumstances and methods used for installation, operation, utilization and maintenance of this working station system. Improper installation can cause damages to material and persons. This is the reason why we do not take over responsibility and liability for losses, damages or cost that might arise due to improper installation, operation or wrong utilization and maintenance or which occur in some connection with the aforementioned. The manufacturer preserves the right to put changes to product, technical date or installation and operation instructions without prior notice. As soon as it becomes evident that safe operation is no longer possible (e.g. visible damage). Please immediate take the device out of operation.

Note: ensure that the device cannot be accidentally placed into operation.

4.Single pipeline working station system SP118

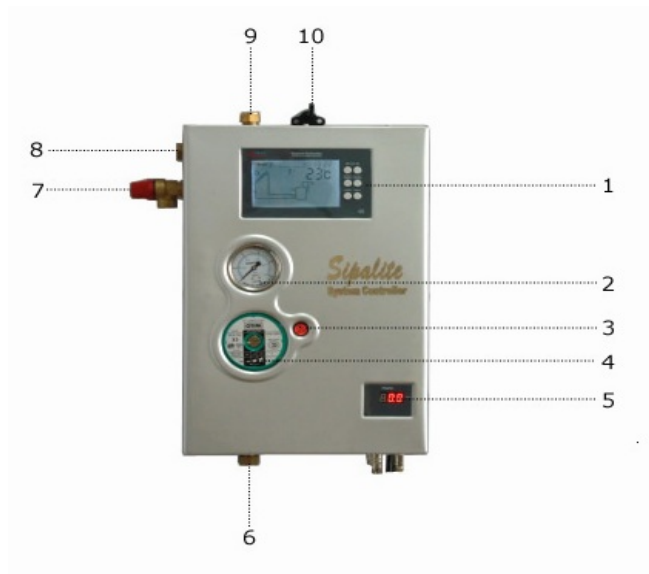

- 1. Operating screen
- 2. Manometer
- 3. Pump speed regulation switches
- 4. Temperature difference circulation pump
- 5. Flow rate indicator
- 6. Return circuit connector
- 7. Safety valve
- 8. Expansion vessel connector
- 9. Return circuit connector
- 10. Wall mounting

Single pipeline connection picture

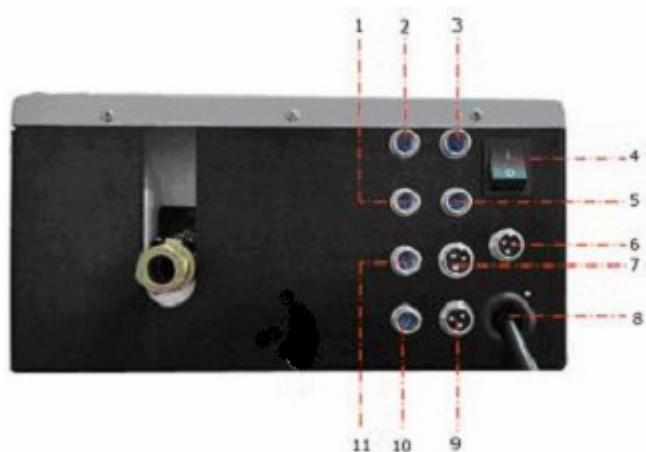

- 1. T3
- 2. T2
- 3. T0
- 4. Power switch
- 5. T1
- 6. P2 pump
- 7. P0 pump or R1 three-way electromagnetic valve
- 8. Power plug and auxiliary heating wire
- 9. R2 three-way electromagnetic valve
- 10. T5
- 11. T4

4.1 Main technical data

- 1. Externality size: 450mm*310mm*150mm
- 2. Max. self consumption: ≤3W
- 3. Accuracy of temperature measuring: ±2
- 4. Range of temperature measuring: 0~150
- 5. Power of controlled pumps (temperature difference circulation pump, water-using end circulation pump) or electromagnetic valve : 600W
- 6. Auxiliary heating power: ≤3000W
- 7. Input signal: 6 temperature sensors (PT1000 for heat collector, NTC 10k B=3950 for water tank)
- 8. Output signal: 5 (1 auxiliary heating, 4 pumps or 3 pumps and 1 three way electromagnetic valve)
- 9. System working pressure: 8bar and safety valve response pressure: 6bar.

4.2 Components of pipeline

- .Safety valve: to make sure the system safety working.
- .Ball valve, check valve: brass material.
- .WILO pump: this pump is a standard device in the system that required operating point can be pre-selected using one of the three levels.
- 4.Manometer adopt hydraulic aseismatic manometer with a range from 0 to 10 bar indicates the system pressure.
- .Connect of expansion vessel install expansion vessel, avoid the system working at minus pressure.
- .Flow sensor: timely monitor medium flow of the whole system.
- 7.Heat preservation material: EPS.
- .Screw thread: 1/2inch.
- .Maximum working temperature of pipeline: 110

Combination picture



4.3 Installation description

SP118 should be installed in return circuit components (pump side) of collector and water tank. See the above picture.

5.Double pipeline working station system SP228

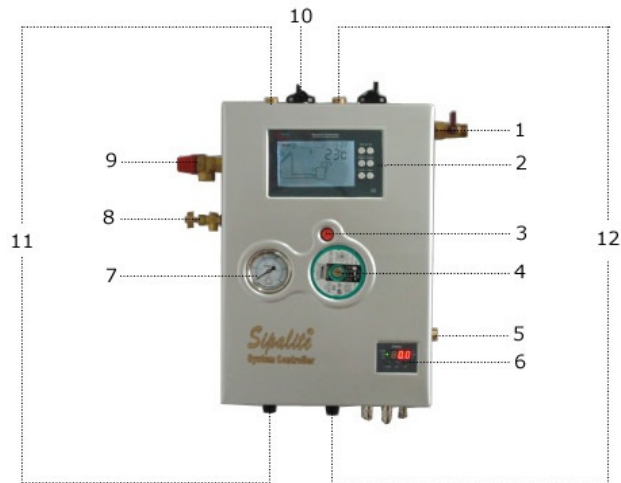

- | | |
|--|------------------------------|
| 1. Inlet inject the medium | 7. Manometer |
| 2. Operating screen | 8. Relieve air valve |
| 3. Pump speed regulation switches | 9. Safety valve |
| 4. Temperature difference circulation pump | 10. Wall mounting |
| 5. Expansion vessel connector | 11. Flow circuit connector |
| 6. Flow rate and temperature indicator | 12. Return circuit connector |

Double pipeline connection picture

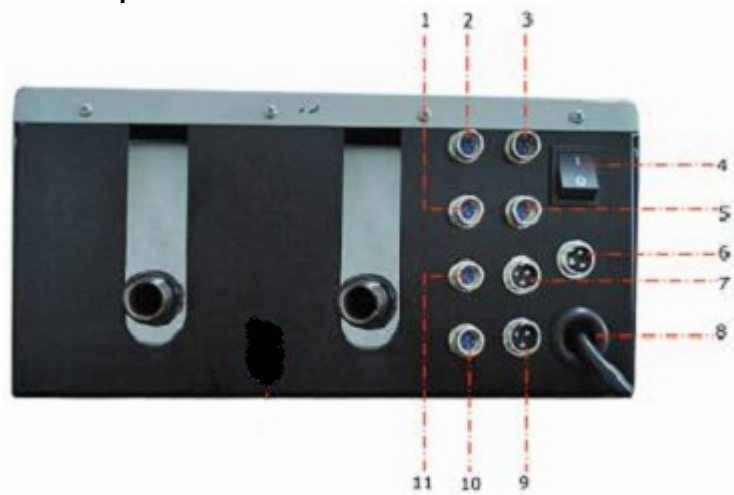

- | | |
|-----------------|--|
| 1. T3 | 7. P0 pump or R1 three-way electromagnetic valve |
| 2. T2 | 8. Power plug and auxiliary heating wire |
| 3. T0 | 9. R2 three-way electromagnetic valve |
| 4. Power switch | 10. T5 |
| 5. T1 | 6. P2 pump |
| | 11. T4 |

5.1 Main technical data

1. Externality size: 450mm*310mm*150mm
2. Max. self consumption: ≤3W
3. Accuracy of temperature measuring: ±2

4. Range of temperature measuring: 0~150
5. Power of controlled pumps (temperature difference circulation pump, water-using end circulation pump) or electromagnetic valve : 600W
6. Auxiliary heating power: $\leq 3000W$
7. Input signal: 6 temperature sensors (PT1000 for heat collector, NTC 10k B=3950 for water tank).
8. Output signal: 5 (1 auxiliary heating, 4 pumps or 3 pumps and 1 three way electromagnetic valve).
9. System working pressure: 8bar and safety valve response pressure: 6bar.

5.2 Components of pipeline

1. Safety valve: protects the system components against excessive over-pressure in all operating phases.
2. Ball valve, check valve: brass material.
3. WILO pump: this pump is a standard device in the system, that required operating point can be pre-selected using one of the three levels.
4. Manometer: adopt hydraulic aseismatic manometer with a range from 0 to 10 bar indicates the system pressure.
5. Connect of expansion vessel: install expansion vessel, avoid the system working at minus pressure.
6. Flow sensor: timely monitor medium flow of the whole system.
7. Exhaust setting: adopt spray-paint steel tube, it can release air cause of medium flow in the pipeline. According air quantity and frequency which cause of system, we can examine whether this system have leakage phenomenon. (Method of operation: counterclockwise rotation to open and clockwise rotation to close.).
8. Pipeline temperature display: medium temperature between flow trip and return trip can be displayed at first time. Temperature sensors are packed in a tube, Do not need to turn off any parts when replace it.
9. Medium inlet: turning the handle 90° to left so that medium can be injected in it.
10. Heat preservation material: EPS
11. Screw thread: 1/2inch
12. Maximum working temperature of pipeline: Flow trip manometer side 150
Return trip (pump side) 110

Combination picture



5.3 Installation description

SP228 should be installed in return circuit components (pump side) and flow circuit components (manometer side) of collector and water tank. See the above picture.

6.Operation instruction

6.1Commissioning



Connect collector and water tank pipeline to the working station system before you connect the power supply! After switching on power to the station, Firstly, "time/week" to be set and "solar system" to be chosen.

Factory setting: In order of safety, auxiliary heating is shut off. This single "🔒" display on the screen. If you want to use auxiliary heating, please see operation: 6.3.21 Permit / prohibit auxiliary heating.

6.1.1 Setting the Clock/ Week

After power is switched on:

- ▶ Press "system setting" button, clock selection are 🕒 display on the screen.
- ▶ Press "←" button to adjust hour of clock, press "→" button to adjust minute of clock..
- ▶ Press "confirm" button to confirm the setting. Press "cancel" button to cancel the setting.
- ▶ Press "system setting" button , week selection are 📅 display on the screen.
- ▶ Press "←" "→" button to adjust week, "Week_ _" display on the screen.
- ▶ Press "confirm" button to confirm the setting, press "cancel" button to cancel the setting.

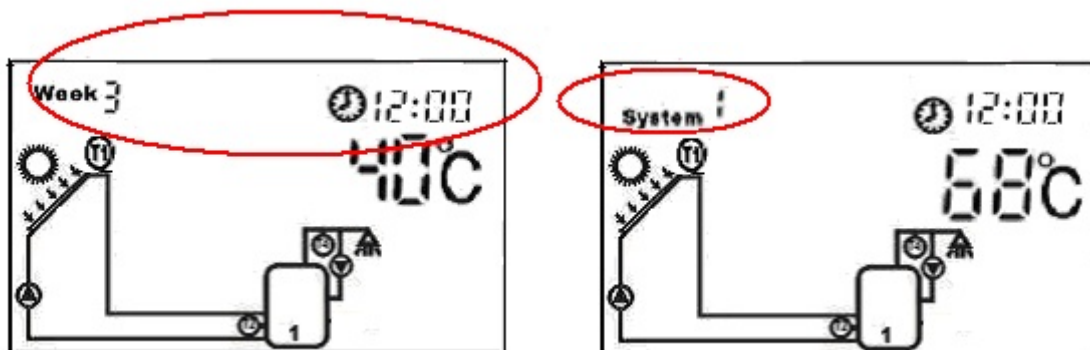

6.1.2 Choosing the solar system

- ▶ Press "system setting" button, until "**System**" display on the screen.
- ▶ Press "←" "→" button to select system. (System 1-8 available to be chosen).
- ▶ Press "confirm" button to confirm the setting, press "cancel" button to cancel the setting.

6.1.3 Operation switch

When there is no function in the display screen:

- ▶ Press "confirm" button to switch on/off solar circuit pump manually.
- ▶ Press "cancel" button to switch on/off hot water circulation pump manually.

6.2 Temperature query function

When you want to know the temperature of temperature sensor at any time

- ▶ Press "←" "→" button to choose the temperature value of T0-T5 one by one.

6.3 Device setup

Note : When only one insert for temperature sensor on tank, and you would like to use auxiliary heating, you must use T3 instead of T2 to insert, Now T3 show the bottom temperature of the tank, and this temperature value is much lower than the actual value of the top. To ensure the security when using auxiliary heating, it

is strongly recommended that using the tank which has two inserts for temperature sensor.

6.3.1 Setting the Clock/ week

- ▶ Press “system setting” button, clock selection area “🕒” display on the screen.
- ▶ Press “▶” button to adjust hour of clock, press “◀” button to adjust minute of clock.
- ▶ Press “confirm” button, confirm the setting. Press “cancel” button, cancel the setting.
- ▶ Press “system setting” button, week selection area “▶” display on the screen.
- ▶ Press “▶” button to adjust week, “Week_ _” display on the screen.
- ▶ Press “confirm” button to confirm the setting, press “cancel” button to cancel the setting.

6.3.2 Systems selection

- ▶ Press “system setting” button, until “**System**” display on the screen.
- ▶ Press “▶” button select system. (System 1-8 available to be chosen).
- ▶ Press “confirm” button to confirm the setting, press “cancel” button to cancel the setting.

6.3.3 System 1

1 collector array – 1 storage tank – 1 pump

Description:

The solar circuit pump (P1) is switched on as soon as the switch-on temperature difference between the collector array (T1) and the storage tank (T2) is reached. If the temperature difference between the collector array (T1) and storage tank (T2) drops below the switch-off temperature difference, or the storage tank (T2) reaches the maximum storage temperature, then the solar circuit pump is switched off.

T1: Temperature sensor for collector 1

T2: Temperature sensor in the bottom part of tank 1

T3: Temperature sensor in the top part of the tank (for control auxiliary heating)

T4: Temperature sensor on hot water pipe

P1: Solar circuit pump 1

P2: Hot water circuit pump

System 1 display

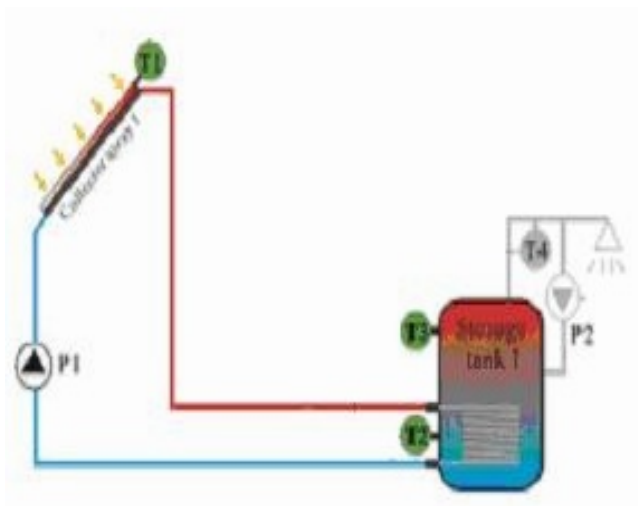
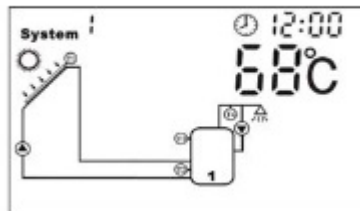

Note:

1.T3, T4, P2 are suitable for system 1-8.

2.T3 is alternative, when no sensor (T3) is installed in the top part of tank, control system will use the signal of sensor T2 automatically to control the auxiliary heating.

6.3.4 System 2

1 collector array – 2 storage tanks – 2 pumps

Description:

If the switch – on temperature difference between the collector array (T1) and one of the two storage tanks (T2 or T5) is reached, then the appropriate solar circuit pump (P1) or (P0) is switched on. According to the priority switching, both storage tanks (T2, T5) are loaded one after the other, until either the relevant switch-off temperature difference between the collector array (T1) and storage tank (T2, T5) is reached, or the maximum storage temperature is reached.

T1: Temperature sensor for collector 1

T2: Temperature sensor in the bottom part of tank 1

T3: Temperature sensor in the top part of the tank (for control auxiliary heating)

T5: Temperature sensor in the tank 2

T4: Temperature sensor on hot water pipe

P1: Solar circuit pump 1

P0: Solar circuit pump 2

Note: the default priority tank is tank 1.

System 2 display

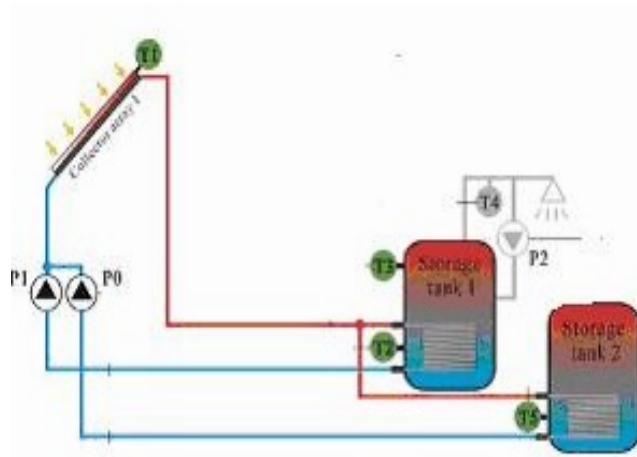
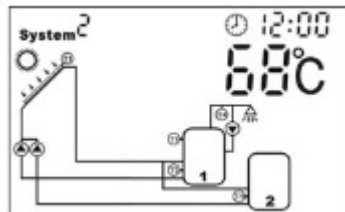

6.3.5 System 3

1 collector array – 2 storage tanks – 1 pump- 1 valve

Description:

If the switch – on temperature difference between the collector

System 3 display

array (T1) and one of the two storage tanks (T2, T5) is reached, then the solar circuit pump (P1) is switched on and the switching valve (R1) is set to the correct position depending on the storage tank to be loaded. According to the priority switching, both storage tanks (T2, T5) are loaded one after the other, until either the relevant switch-off temperature difference between the collector array (T1) and two storage tanks (T2, T5) falls below the threshold, or the maximum storage temperature of T2 or T5 is reached.

T1: Temperature sensor for collector 1

T2: Temperature sensor in the bottom part of tank 1

T5: Temperature sensor in the tank 2

P1: Solar circuit pump 1

R1: 3-way electromagnetic valve

Note: When no power is in the system, the electromagnetic valve (R1) must be set to storage tank 1 (T2)

*** The default priority tank is tank 1.**

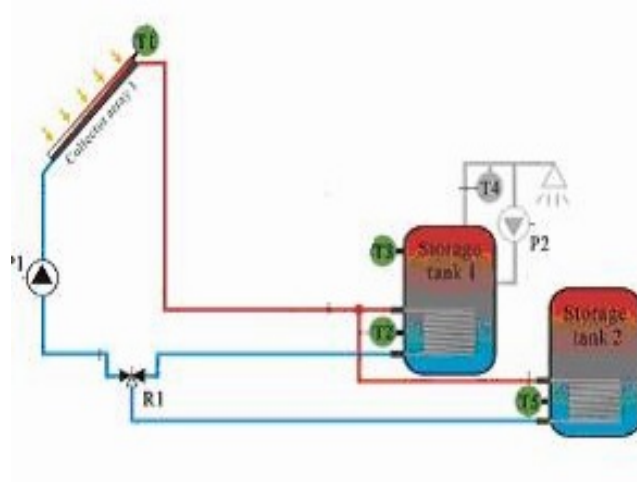
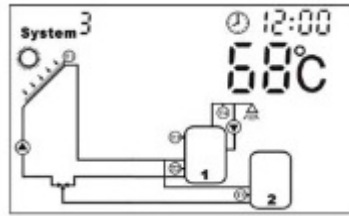

6.3.6 System 4

2 collector arrays (east/west roof) – 1 storage tank – 2 pumps

Description:

If the switch – on temperature difference between the storage tank (T2) and one or the other of the collector array (T1, T0) is reached, then the solar circuit pump (P1) for collector array 1 (T1) or solar circuit pump (P0) for collector array 2 (T0) is switched on, depending on where the temperature difference occurs. If the switch-on temperature difference is reached for both collector arrays (T1, T0), then both pumps (P1, P0) are switched on. The pumps switch off

System 4 display

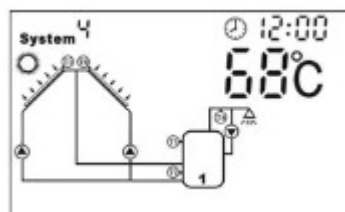

independently of each other. When either the relevant switch off temperature difference between one or both collector arrays (T1, T0) and the storage tank (T2) falls below the threshold, or the maximum storage temperature is reached, and then the corresponding circuit pump is switched off.

T1: Temperature sensor for collector 1

T0: Temperature sensor for collector 2

T2: Temperature sensor in the bottom part of tank 1

P1: Solar circuit pump 1

P0: Solar circuit pump 2

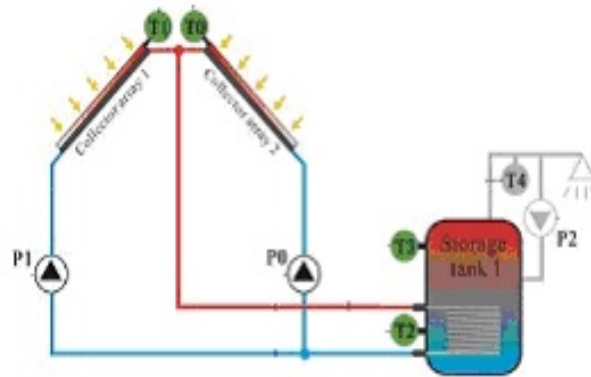

6.3.7 System 5

2 collector arrays (east/west roof) –
1 storage tank -1pump – 1valve

Description:

The solar circuit pump (P1) is switched on as soon as the switch – on temperature difference between one of the two collector arrays (T1, T0) and storage tank 1 (T2) is reached, the switch valve R1 is always set so that flow occurs through the warmer of the two collector arrays (T1, T2). The pump P1 switches off as soon as the switch-off temperature difference between the two collector arrays (T1, T0) and the storage tank (T2) falls below the threshold or the maximum storage temperature is reached.

T1: Temperature sensor for collector 1

T0: Temperature sensor for collector 2

T2: Temperature sensor in the bottom part of tank 1

P1: Solar circuit pump 1

R1: 3-way electromagnetic valve

Note:

When no power is in the system, the electromagnetic valve (R1) must be set to collector array 1 (T1).

System 5 display

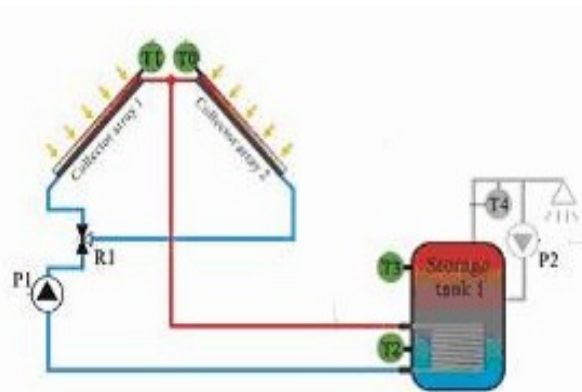
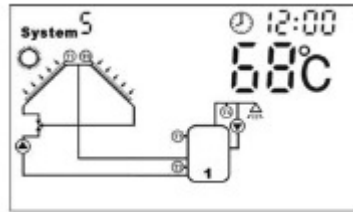

6.3.8 System 6

Valve-controlled 2 collector arrays
(east/west roof) – 2 storage tanks –
1 pump – 2 valves

Description:

If the switch-on temperature difference between one of the two tanks (T2, T5) and collector array1 (T1) or collector array 2 (T0) is reached, then the solar circuit pump (P1) is switched on, electromagnetic valve (R1) switches the relevant tank into the solar circuit, and electromagnetic

System 6 display

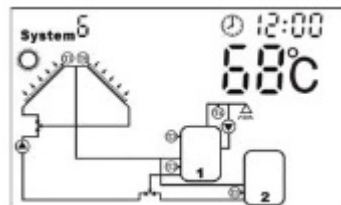

valve (R2) switches the affected collector array (T1 or T2) into the solar circuit also. Switching valve 1 (R1) is always set so that flow occurs through the warmer of the two collector arrays (T1, T0). Switching valve 2 (R2) controls the loading of the storage tanks (T2, T5) according to the priority switching. Pump (P1) switches off when the switch-off temperature difference between either or both collector arrays and its corresponding storage tank1 (T2) and storage tank2 (T5) falls below the threshold or the maximum storage temperature (T2 or T5) is reached.

T1: Temperature sensor for collector 1

T0: Temperature sensor for collector 2

T2: Temperature sensor in the bottom part of tank 1

T5: Temperature sensor in the bottom part of tank 2

P1: Solar circuit pump 1

R1: 3-way electromagnetic valve 1

R2: 3-way electromagnetic valve 2

Note:

* When no power is in the system, the electromagnetic valve 2 (R2) must be set to tank 1 (T2), the electromagnetic valve 1 (R1) must be set to collector array 1 (T1).

* Default priority tank is tank 1 (T1).

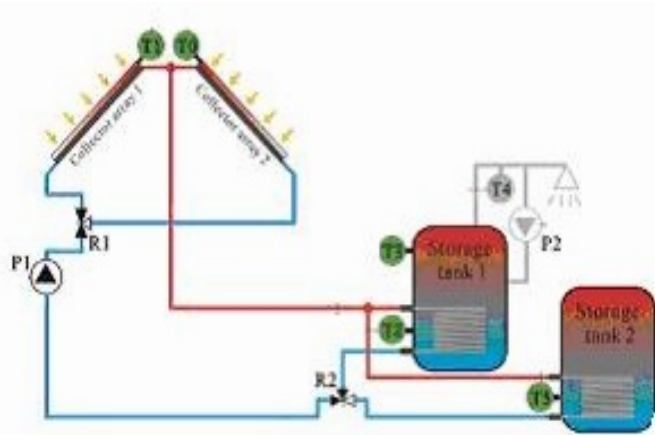

6.3.9 System 7

Valve-controlled 2 collector arrays (east/west roof) – 2 storage tanks – 2 pumps – 1 valve

Description:

If the switch-on temperature difference between one of the two tanks (T2, T5) and collector array 1 (T1) or collector array 2 (T0) is exceeded, then the switching valve R2 switched the corresponding collector array (T1 or T0) into the

System 7 display

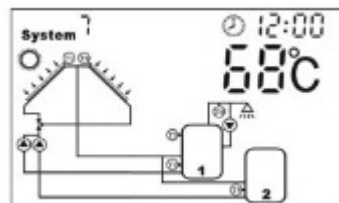

solar circuit. Depending on which storage tank has reached the switch-on temperature, solar circuit pump (P1) for storage tank 1 (T2) or solar circuit pump (P0) for storage tank 2 (T5) is switched on. The switching valve R2 is always set so that flow occurs through the warmer of the two collector arrays. Both storage tanks (T2, T5) are loaded one after the other, according to the priority switching, until either the relevant switch-off temperature difference falls below the threshold, or the maximum storage temperature (T2 or T5) is reached.

T1: Temperature sensor for collector 1

T0: Temperature sensor for collector 2

T2: Temperature sensor in the bottom part of tank 1

T5: Temperature sensor in the bottom part of tank 2

P1: Solar circuit pump 1

P0: Solar circuit pump 2

R2: 3-way electromagnetic valve

Note:

* When no power is in the system, the electromagnetic valve (R2) must be set to collector array 1(T1).

* Default priority tank is tank 1(T1).

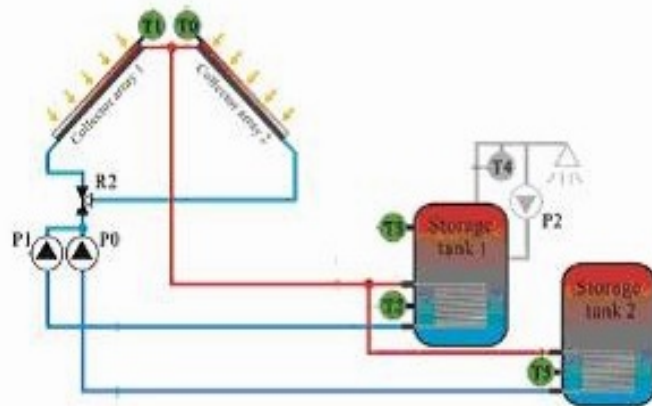

6.3.10 System 8

Pump controlled 2 collector arrays (east/west roof) – 2 storage tanks – 2 pumps – 1 valve

Description:

If the switch-on temperature difference between one of the two tanks (T2, T5) and collector array1 (T1) and collector array 2 (T0) is exceeded, then the switching valve (R2) switches the relevant storage tank (T2, or T5) into the solar circuit. If the switch-on temperature difference between the storage

System 8 display

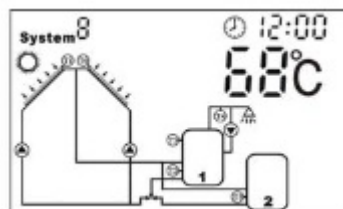

tanks (T2, T5) and one of the collector arrays (T1, T0) is reached, then either solar circuit pump P1 for collector array1 (T1), or solar circuit pump P0 for collector array2 (T0) is switched on, depending on where the temperature difference occurs. If the switch-on temperature difference is reached for both Collector arrays (T1, T0), then both pumps (P1, P0) are switched on. The electromagnetic valve (R2) controls the loading of the storage tank (T2, T5) according to the priority switching. The pumps (P1, P0) switch off independently of each other, when either the relevant switch-off temperature for one or both of the collector arrays (T1, T0) with regard to the storage tanks (T or T) falls below the threshold, or the maximum storage temperature is reached.

T1: Temperature sensor for collector 1

T0: Temperature sensor for collector 2

T2: Temperature sensor in the bottom part of tank 1

T5: Temperature sensor in the bottom part of tank 2

P1: Solar circuit pump 1

P0: Solar circuit pump 2

R2: 3-way electromagnetic valve

Note:

* When no power is in the system, the electromagnetic valve (R2) must be set to storage tank 1(T1). Default priority tank is tank 1(T1).

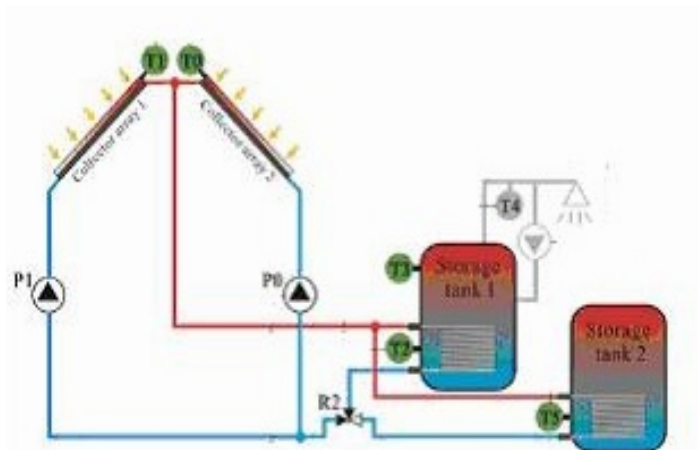

6.3.11 On/Off of temperature difference setting function for temperature difference circulation pump Functional description:

Solar circuit pump P1 is triggered by temperature difference function, so long as the preset temperature difference between collector and tank is reached, solar pump is switched on.

When there are two tanks or two collector arrays, system will compare the temperature between one tank and one collector, one extra number indicates the correspondingly tank or collector.

Important information:

The switch-on temperature difference 10 and the switch-off temperature 5 . To avoid mistake the minimum difference between two temperature differences ($\Delta T_{on} - \Delta T_{off}$) is 2 .

Setup steps:

- ▶ Press “system setting” button, when  display on the screen.
- ▶ Press “◀ ▶” button to adjust storage tank temperature ,default value is 60 .(adjust range: 45~75)
- ▶ Press “confirm” button to confirm the setting. Then enter into switch on temperature difference setting of temperature difference circulation pump.
- ▶ Press “◀ ▶” button to adjust temperature, adjustable range:[(OFF +2) ~20 , default value is 10]
- ▶ Press “confirm” button to confirm the setting. Then enter into switch off temperature difference setting of temperature difference circulation pump.
- ▶ Press “◀ ▶” button to adjust temperature, adjustable range: [0 ~ (ON-2) , default value is 5] .
- ▶ Press “confirm” button confirm the setting. Press “cancel” button to cancel the function.

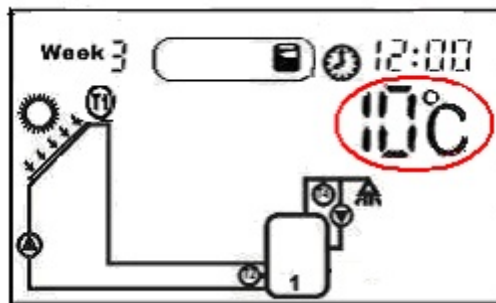

Kindly note: During 60 ~70 it is easy to appear boiler scale, so we usually set the water tank temperature at 60 .

6.3.12 Protection for water tank at high temperature

Functional description:

To avoid the temperature in tank is too high; system will start its maximum tank temperature protection function. System checks the temperature which getting from bottom part of tank and compares it with turning-on and turning-off temperature of this function, when the temperature is higher than the turning-on temperature, solar circuit pump is stopped, when the temperature is lower than tuning-off temperature, solar circuit pump is triggered automatically. When the temperature of tank is higher than the maximum tank temperature, even the condition of temperature difference circulation is reached, solar pump is still forbidden to trigger.

Activate/deactivate this function:

- ▶ Press “choose function” button, when  display on the screen.
- ▶ Press “◀ ▶” button to adjust the maximum tank temperature (adjustable range: 50 – 95), default value is 80 .
- ▶ Press “confirm” button to confirm the setting, press “cancel” to deactivate the function.



When this signal of maximum tank temperature is displayed on screen, it indicates this function is activated. When the signal isn't display on screen, it indicated this function is deactivated.

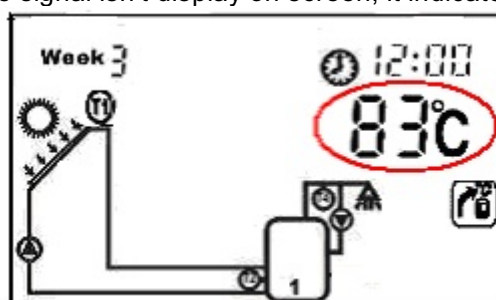

6.3.13 Protection for collector at high temperature

Functional description:

If the hot water in tank isn't used, temperature in solar circulation will rise automatically after long time sunshine. The heat loss through the collector will increase with the rising of temperature of heat transfer liquid; Through setting the maximal temperature of collector can realize the cooling of collector.

Activate/deactivate this function:



- ▶ Press "choose function", when the icon is displayed on the screen.
- ▶ Press "left" "right" button to adjust the maximum collector temperature (adjustable range: 100 –140), default value is 115 .
- ▶ Press "confirm" button to confirm the setting, press "cancel" button to deactivate this function.



When this signal of maximum collector temperature display on the screen, it indicates this function activated. When the signal isn't display on the screen, it indicated this function is deactivated.

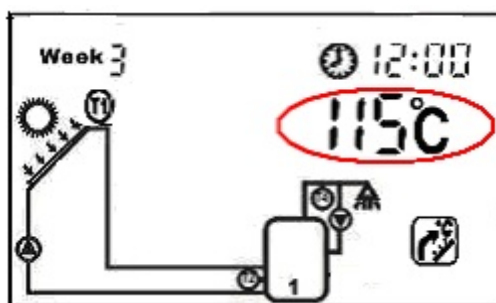

6.3.14 Collector emergency cut-off

Functional description:

When the temperature of collector exceeds 120 , in order to protect the other components of solar circuit, solar circuit pump is shut off compulsively.

Restart conditions: the temperature of collector drops below 100 and tank temperature drops below the maximum tank temperature.

6.3.15 Protection for collector at low temperature

Functional description:

When the temperature of collector is below 15 , even when the temperature difference exceeds switch-on temperature difference, solar pump doesn't work.

When the temperature of collector is above 20 , solar pump starts to work.

6.3.16 Collector/ pipeline frost protection

Functional description:

In Winter when the temperature of collector is below the preset frost protection temperature (2 -15), solar pump starts work. When the temperature of collector exceeds the switch-off temperature of frost protection, switch-off circulation pump and exit frost protection. After starts frost protection when water tank temperature below 5 of switch-off frost protection. Immediately start up auxiliary heating until 20 or exit the program.

Activate/deactivate this function:



- ▶ Press "choose function", when the icon is displayed on the screen.
- ▶ Press "left" "right" button to adjust the temperature of frost protection, (adjustable range: 0 –15), default value is 5 .
- ▶ Press "confirm" button to confirm the setting, press "cancel" button to deactivate this function.



When the signal displays on screen, it indicates frost protection function is activated. When the signal isn't display on screen, it indicated this function is deactivated.

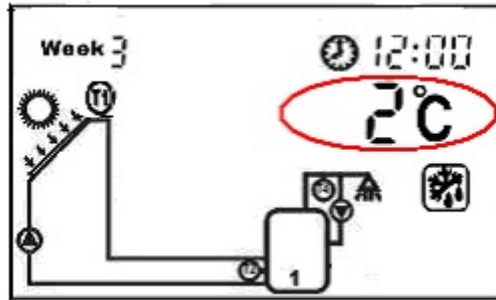

6.3.17 Temperature-setting for hot water circulation pump

Functional description:

Solar system can provide temperature-controlled the hot water circulation function, this function needs an extra hot water circulation pump (P2) and a sensor (T4), which is positioned on the return pipe of hot water. When the temperature signal of sensor T4 is less than the preset turning on temperature, the hot water circulation pump (P2) triggers and works till the temperature exceeds the turning off temperature.

The default turning on temperature is 39 ; default turning off temperature is 45 .

Activate/deactivate this function:



- ▶ Press “choose function”, then the icon “ ” display on the screen.
- ▶ Press “◀ ▶” button to adjust the temperature of circulation pump, (adjustable range: 20 –50).
- ▶ Press “confirm” button to confirm the setting, press “cancel” button to deactivate this function.

Note: the position of the sensor T4 should be minimum 1.5m far from tank, so that avoid the measuring error.

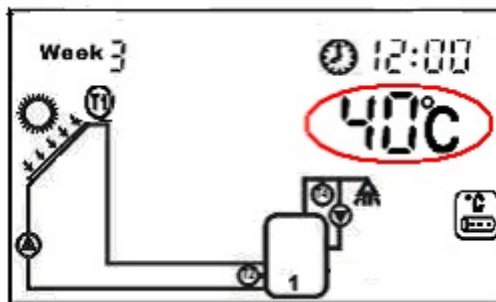

6.3.18 Time-setting for hot water circulation pump

Function description:

Solar system can provide time-controlled hot water circulation function, this function needs an extra circulation pump (P2), this pump can be triggered by preset time. Within the preset time section pump operates for three minutes, and then stops for 15 minutes, same process continues so. Three time sections can be set within one day.

Setup steps:

- ▶ Press “ system setting”, when the icon “ ” display on the screen.
- ▶ Press “◀ ▶” button to adjust the first time section of switch on, Press “ ” button to adjust hour of clock, press “▶ ” button to adjust minute of clock. Press “confirm” button to confirm the setting, Press “cancel” button to cancel this setting.
- ▶ Press “◀ ▶” button to adjust the first time section of switch off. Press “ ” button to adjust hour of clock, press “▶ ” button to adjust minute of clock. Press “confirm” button to confirm the setting, Press “cancel” button to cancel this setting.
- ▶ Press “◀ ▶” button to adjust the second time section of switch on/off. Press “confirm” button to

confirm the setting, Press “cancel” button to cancel this setting.

▶ Pres◀▶ “ ” button to adjust the third time section of switch on/off. Press “confirm” button to confirm the setting, Press “cancel” button to cancel this setting.

- Doing like above steps. Within one day, three time sections can be set.
- Default setting: First time section: 6:00 turning on, 8:00 turning off. Second time section: not working, setting is 10:00 ~10:00. Third time section: 19:00 turning on, 21:00 turning off.
- If you want to shut off one timing circulation, then you set the turning on time and turning off time same value (for example, deactivate the function in the second time section, then you can set turning on/off time is 10:00 ~ 10:00)

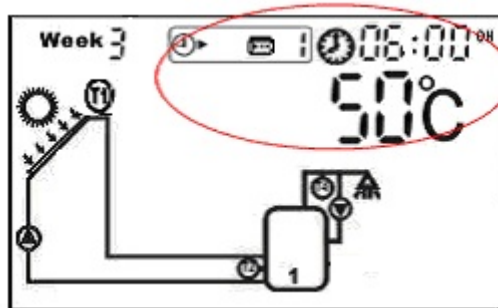

6.3.19 Time controlled auxiliary heating at preset three time sections

Functional description:

Solar system can be combined with auxiliary heating or gas, oil boiler, system can achieve automatically temperature and timing controlled heating, during the preset time sections auxiliary heating starts working when the temperature (T3) of top part of tank is below the preset turning on temperature, when T3 exceeds the preset turning off temperature, auxiliary heating stops heating.

Setup steps:

- ▶ Press “system setting”, when  display on the screen.
- ▶ Pres◀▶ “ ” button to adjust the first time section of switch on, Press “ ” button to adjust hour of clock, press “▶ ” button to adjust minute of clock. Press “confirm” button to confirm the setting, Press “cancel” button to cancel this setting.
- ▶ Pres◀▶ “ ” button to adjust the first time section of switch off. Press “ ” button to adjust hour of clock, press “▶ ” button to adjust minute of clock. Press “confirm” button to confirm the setting, Press “cancel” button to cancel this setting.
- ▶ Pres◀▶ “ ” button to adjust the second time section of switch on/off. Press “confirm” button to confirm the setting, Press “cancel” button to cancel this setting.
- ▶ Pres◀▶ “ ” button to adjust the third time section of switch on/off. Press “confirm” button to confirm the setting, Press “cancel” button to cancel this setting.
- Doing like above described steps, three timing sections can be set (1-3 displays)
- Default setting: First heating time section: 4:00 turning on, 5:00 turning off Second heating time section: not working, setting is 10:00 ~10:00. Third heating time section: 17:00 turning on, 22:00 turning off.
- If you want to shut off one timing heating, then you set the turning on time and turning off time same value (for example, the second time section no this function, then you can set turning on/off time is 10:00 ~ 10:00)
- System has memory function, your setting is remembered, and you don't need to set everyday.

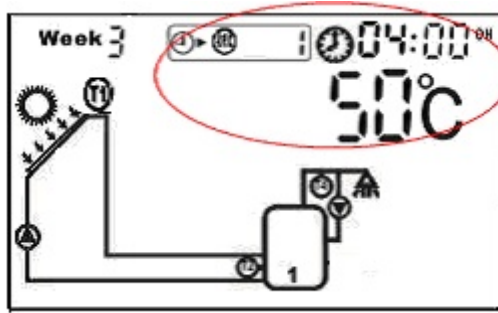

Note: when no temperature sensor (T3) is installed in the top part of tank or T3 is damaged, controller will take the signal from bottom temperature sensor (T2) automatically and there of control auxiliary heating function.



When this signal displays on screen, it indicates the function activated. When the signal isn't display on screen, it indicates this function is deactivated.

6.3.20 Holiday function

Function description:

This function activated nightly storage tank back cooling and prevents high thermal loads of the solar system due to completely heated storage tank. The function is activated when the collector temperature falls 8 below the storage tank temperature at night between 10 pm and 6 am.

Start up this function at below case:

- You intend to be absent for an extended period (holiday)
- No hot water is required for an extended period.

The function is deactivated when the temperature in lower section of storage tank falls down to 35 .

Activating/deactivating the function:



- ▶ Press "choose function", whe " " display on the screen, it indicates the function is active.
- ▶ Press "confirm" button to confirm this setting. Press "cancel" button to deactivate this function.

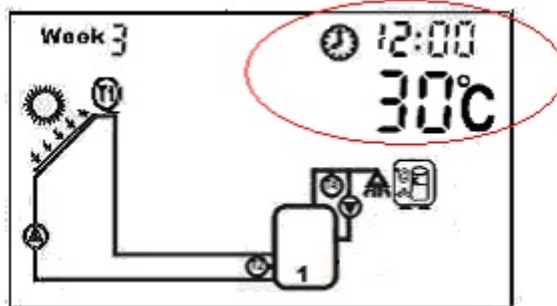

6.3.21 Permit / prohibit auxiliary heating

- ▶ Press "choose function" button, whe " " display on the screen.
- ▶ Press "confirm" button to confirm the setting, an " " blinks on screen. It indicates forbid to use the auxiliary heating.
- ▶ Press "cancel" to cancel this function, an " " will disappear, it indicates permit to use auxiliary heating.

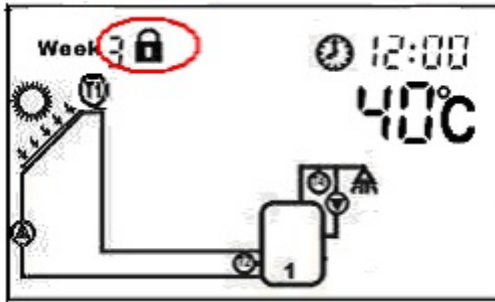

6.3.22 Switch on /off auxiliary heating manually

Functional description:

When auxiliary heating work at anytime, use this function, you can Switch on /off the auxiliary heating .

Setup steps:

- ▶ Press “choose function” button, when  display on the screen.
- ▶ Press “confirm” button to switch on the auxiliary heating
- ▶ Press “cancel” button to switch off the auxiliary heating

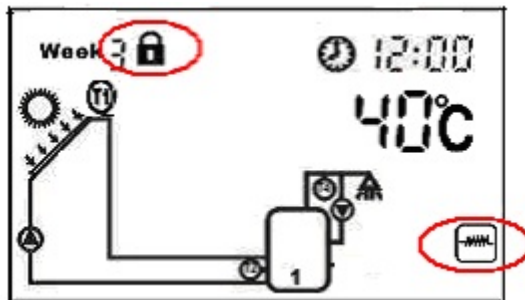

6.3.23 Auxiliary function

Note: the following described functions need an extra output R2 to control pump or electromagnetic valve, when all output are occupied, the desired function can't be activated.

a Temperature difference controlling

When T0, T5, R2 are not display on the screen. The function of temperature difference controlling start up.

- ▶ Press “choose function” button, when  display on the screen.
- ▶ Press “confirm” button to start up this function. Press “cancel” to cancel this function.

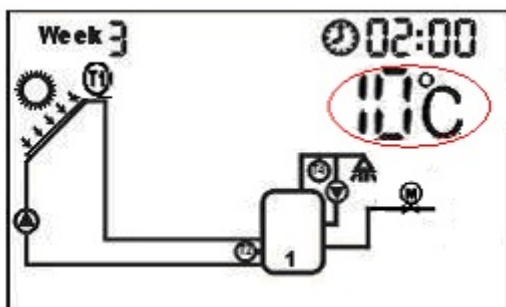

When this signal displays on screen, it indicates the function activated. When the signal isn't display on screen, it indicated this function is deactivated.

b. High temperature by-pass

Function description:

This function allows reducing the temperature in tank by using radiator, if the temperature in tank is too high, this function is triggered.

- ▶ Press “choose function” button, when  display on the screen.
- ▶ Press “◀ ▶” to adjust the switch-on temperature (T2) for high temperature by-pass. Adjustable range: 50 ~ 99 .
- ▶ Press “confirm” button to confirm the setting. Press “cancel” button to deactivate this function.

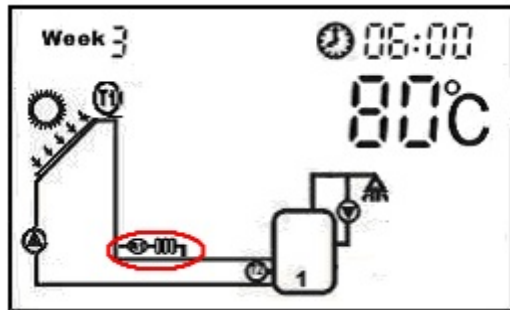

6.3.24 Auto function

- ▶ Press “choose function” button, when  display on the screen.
- ▶ Press “confirm” button, all values of system parameters are set to the factory settings.

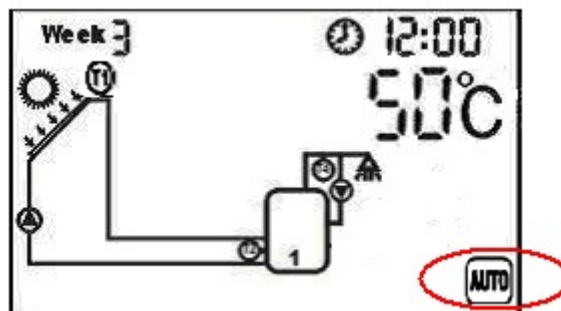

6.3.25 Protection function

a. Memory protection when power is failure

In case power failure occurs, controller keeps the parameter setting unchanged.

b. Anti -bacteria protection

In order to not effect the health of customer and to prevent to breed bacteria when tank temperature is lower for a long time, system will check the temperature of tank every 7 days in a period automatically, if the temperature of tank is never over 70 during the period, then at the default time of 23:00 on the seventh day the period of auxiliary heating system is triggered automatically, when the temperature rise up to 70 , the auxiliary heating stops, bacteria is killed.

6.4. Trouble shooting







6.4.1 Trouble protection

- a. When there is a break or short circuit between the connection of temperature sensors, system switches off the corresponding functions and no more output signals are given, at the same time error indications are showed on the display.

b. Error messages indication

If working station system does not work correctly, please check following points, warning signal is displayed on screen.

Error messages and handling indication (LCD display warning signal blinks)

Error message	Meaning	Cause of error	Error rectification
T0  blinks	There is a break or short circuit between sensor connections	Sensor wiring interrupted, not connected or short circuit	Check resistance value, replace sensor if necessary
T1  blinks	There is a break or short circuit between sensor connections	Sensor wiring interrupted, not connected or short circuit	Check resistance value, replace sensor if necessary
T2  blinks	There is a break or short circuit between sensor connections	Sensor wiring interrupted, not connected or short circuit	Check resistance value, replace sensor if necessary
T3  blinks	There is a break or short circuit between sensor connections	Sensor wiring interrupted, not connected or short circuit	Check resistance value, replace sensor if necessary
4  blinks	There is a break or short circuit between sensor connections	Sensor wiring interrupted, not connected or short circuit	Check resistance value, replace sensor if necessary
T5  blinks	There is a break or short circuit between sensor connections	Sensor wiring interrupted, not conneded or short circuit	Check resistance value, replace sensor if necessary

Note: when the error of sensor appears, its corresponding function will be switched off automatically.

6.4.2 Error checking

a. A potentially defective sensor can be checked using an ohmmeter. To do this, the sensor must be disconnected, its resistance measured, and the value compared with the figures in the table below, small deviation are acceptable,

Note: remove the device from the mains supply before opening the case

PT1000 resistance value

	0	10	20	30	40	50	60	70	80	90	100	110	120
Ω	1000	1039	1077	1116	1155	1194	1232	1270	1309	1347	1385	1422	1460

NTC 10K B=3950 resistance value

	0	10	20	30	40	50	60	70	80	90	100	110	120
Ω	33620	20174	12535	8037	5301	3588	2486	1759	1270	933	697	529	407

b. Cause of failures

Symptoms	S e c o n d a r y symptoms	Possible cause	Procedure
Controller does not appear to function at all	Display shows nothing, no display illumination.	Controller power supply is interrupted.	Check the controller power cable

The solar pump doesn't operate, despite the fact that switch-on conditions are satisfied	The pump symbol in the display blinks.	Pump power supply is interrupted.	Check the pump power cable
Pump doesn't operate	The pump symbol in the display doesn't blink.	The maximum storage tank temperature has been reached Then maximum collector temperature has been reached	No fault
	The pump symbol in the display doesn't blink, error message signal "T_" blinks on  the display screen.	Fault (short circuit or open circuit) in a temperature sensor.	On the controller, request the current values from all connected temperature sensors, replace all defective sensors and/or cabling.
The solar pumps operated, despite the fact that the switch-on conditions are not satisfied.	The pump symbol in the display blinks.	The holiday function is activated. The frost protection function is activated.	No problem, it is normal. If necessary to deactivate the corresponding functions.